

CETOP 03 - DISTRIBUTORE CON COMANDO A LEVA

Caratteristiche

TIPO	Pressione massima	Portata massima consigliata	Massa
DC-03-*-*	350 bar	50 l/min	0.8 Kg.

Descrizione

Distributore a cursore a quattro vie a due o tre posizioni ad azionamento manuale Cetop-03.

Dimensioni

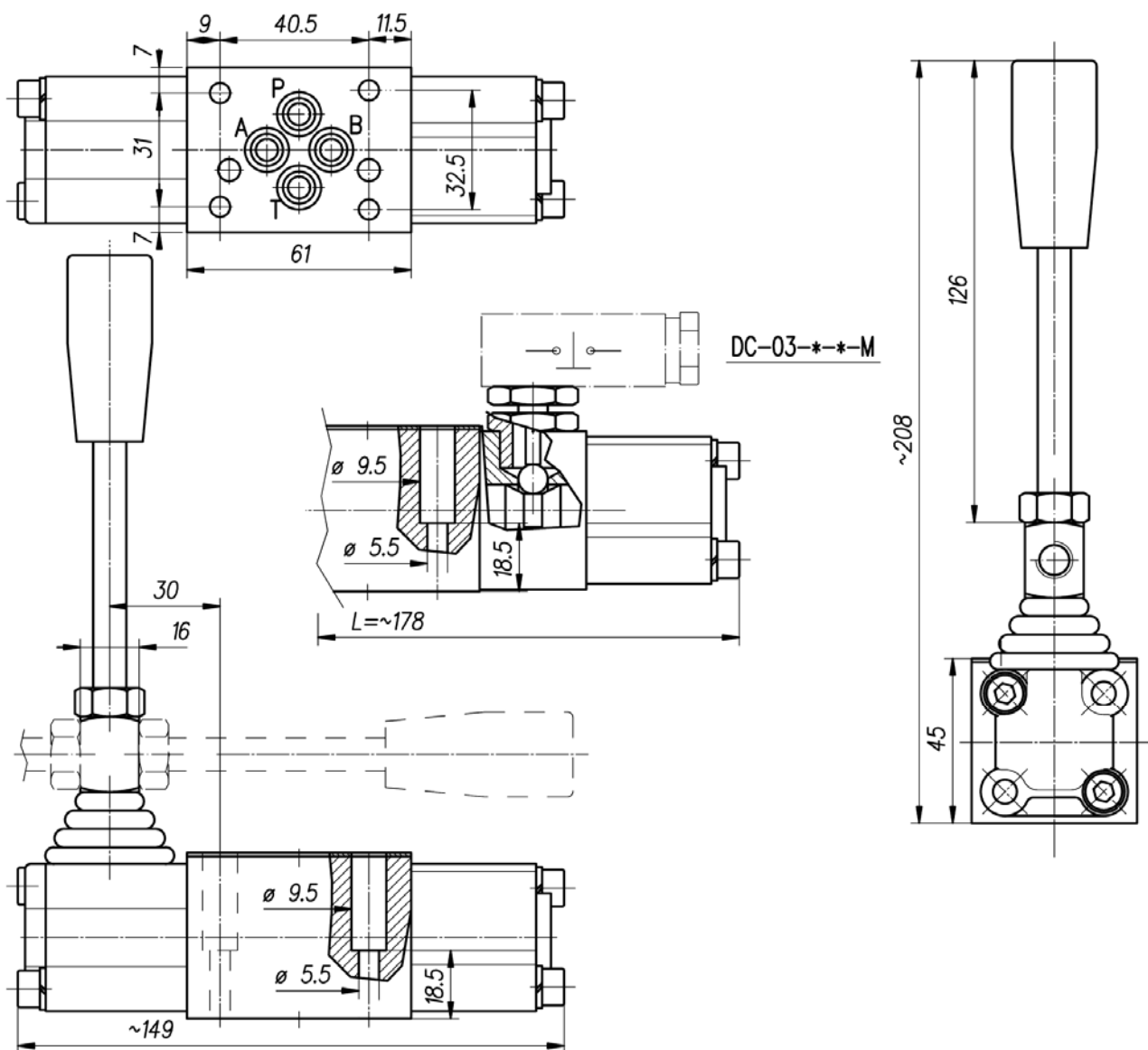

Norme di installazione

- I distributori DC-03 possono essere montati in qualsiasi posizione.
- Fluido da utilizzare: olio idraulico a norme DIN 51524 con viscosità compresa tra 30 e 100 mm²/s (cSt) a 40°C
- Filtrazione richiesta del fluido impiegato 25 μ
- Temperatura fluido idraulico: da -20° a +75°C

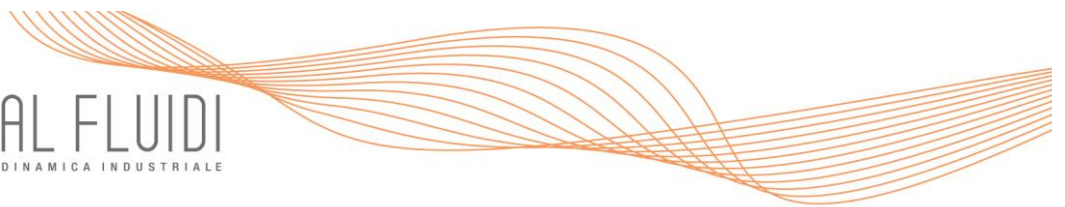

CETOP 03 - DISTRIBUTORE CON COMANDO A LEVA

TABELLA "A"

TABELLA "B"

Tipo di comando

Tipo di cursore

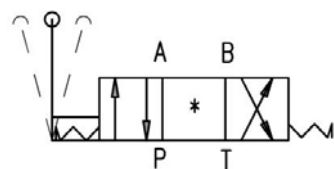
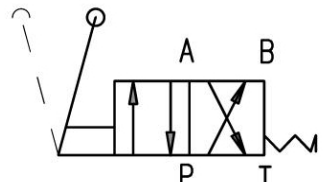
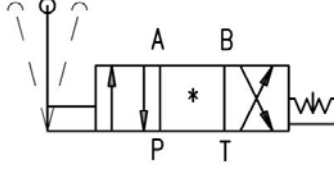
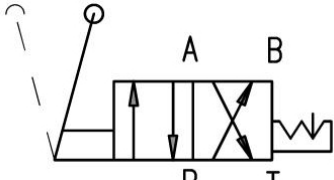
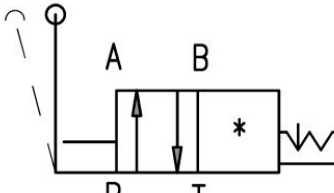
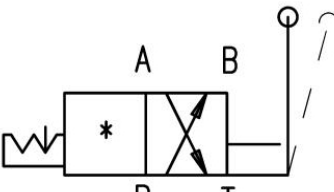
1	<p>3 posizioni ritorno a molla al centro</p> 
2	<p>2 posizioni - ritorno a molla in posizione interna</p> 
4	<p>3 posizioni - detent nelle 3 posizioni</p> 
5	<p>2 posizioni - detent nelle 2 posizioni</p> 
6	<p>2 posizioni - detent nelle 2 posizioni</p> 
6*/A	<p>2 posizioni - detent nelle 2 posizioni</p> 

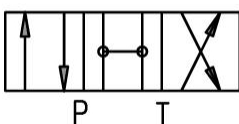
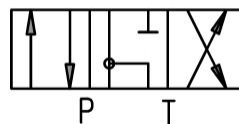
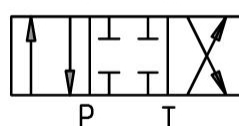
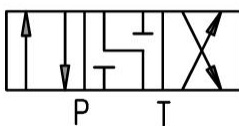
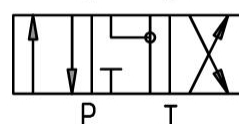
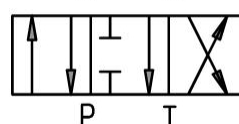
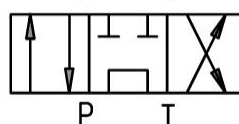
0	<p>A B</p>  <p>P T</p>	5	<p>A B</p>  <p>P T</p>
1	<p>A B</p>  <p>P T</p>	6	<p>A B</p>  <p>P T</p>
3	<p>A B</p>  <p>P T</p>	7	<p>A B</p>  <p>P T</p>
4	<p>A B</p>  <p>P T</p>		